

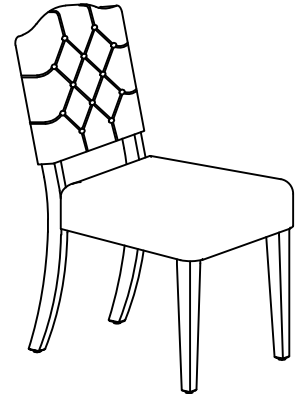







### Warning :

- Be sure to check all packing material carefully for small parts, which may have come loose inside the carton during shipment.
- To prevent possible scratches and damage, this furniture must be assembled on a soft surface such as a blanket or carpet.

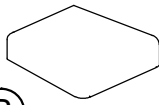
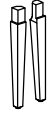

92630 / 31 / 32  
Button Tuft Uph Chair

### Components and Hardware List

<p>Chair Back</p>  <p>(A) 1 pc.</p>	<p>Seat Frame</p>  <p>(B) 1 pc.</p>	<p>Front Leg</p>  <p>(C) 2 pcs.</p>	<p>Allen Head Bolt Ø5/16" x 18 x 3-3/8"</p>  <p>(D) 4 pcs.</p>	<p>Allen Head Bolt Ø5/16" x 18 x 2-1/8"</p>  <p>(E) 4 pcs.</p>
<p>Allen Head Bolt Ø5/16" x 18 x 1-3/4"</p>  <p>(F) 2 pcs.</p>	<p>Ø5/16" Spring Washer</p>  <p>(G) 10 pcs.</p>	<p>Ø5/16" Flat Washer</p>  <p>(H) 10 pcs.</p>	<p>4mm Allen Key</p>  <p>(I) 1 pc.</p>	

**STEP 1:** Remove Velcro strips on the seat frame to assemble the chair back and front legs.

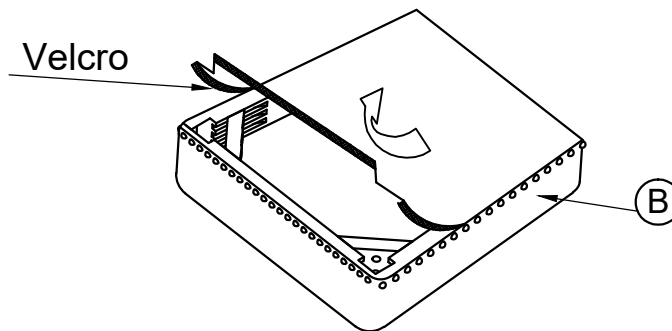

**STEP 2:**

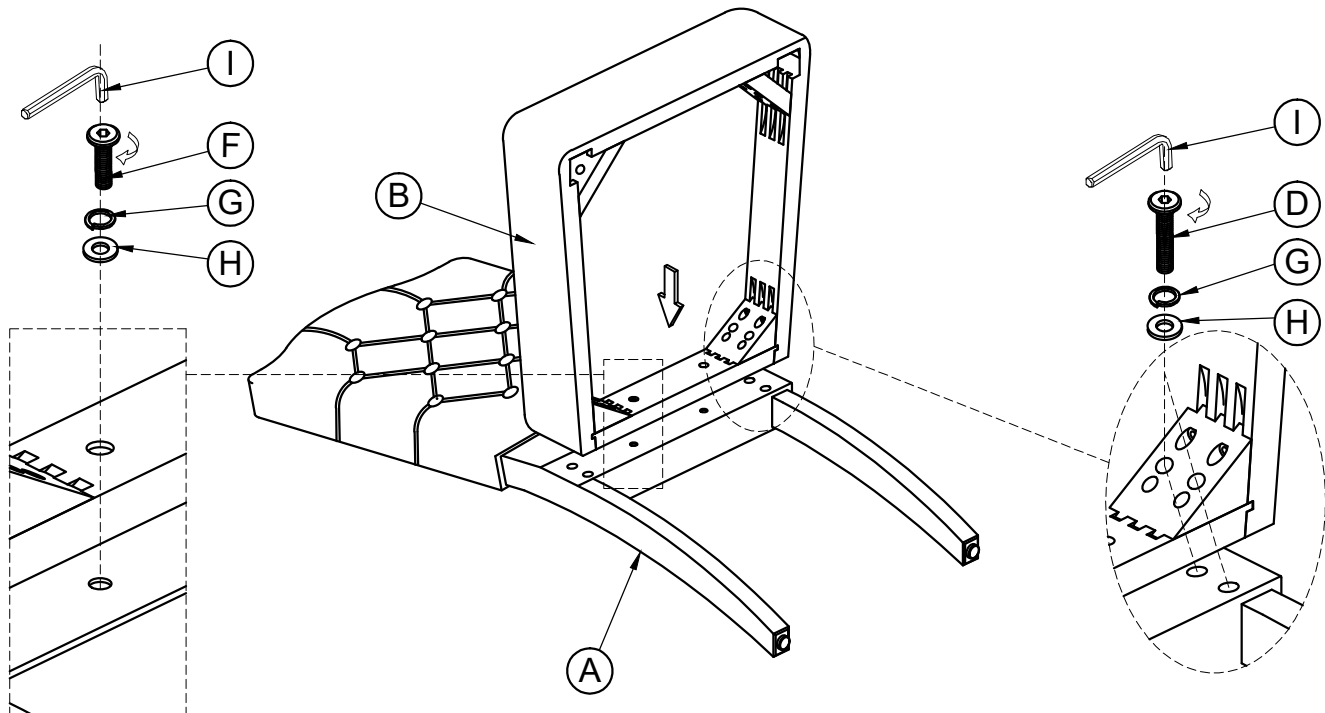

**STEP 3:**

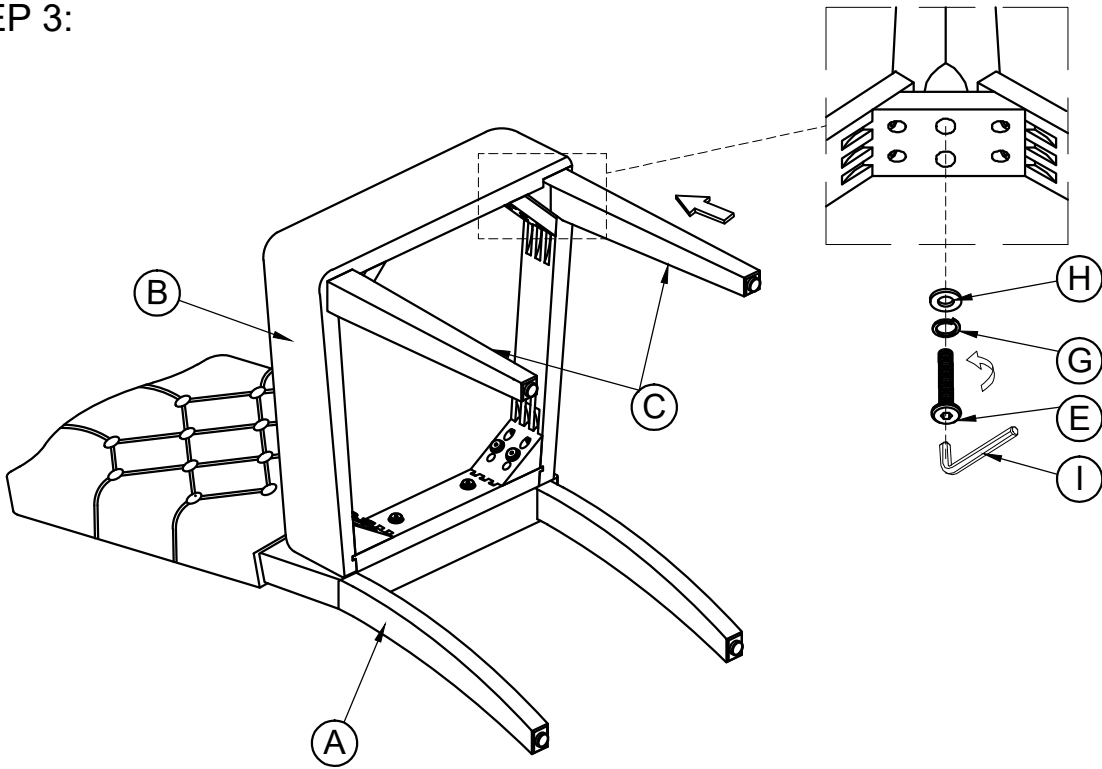

**STEP 4: Attach all Velcro strips to the seat frame.**

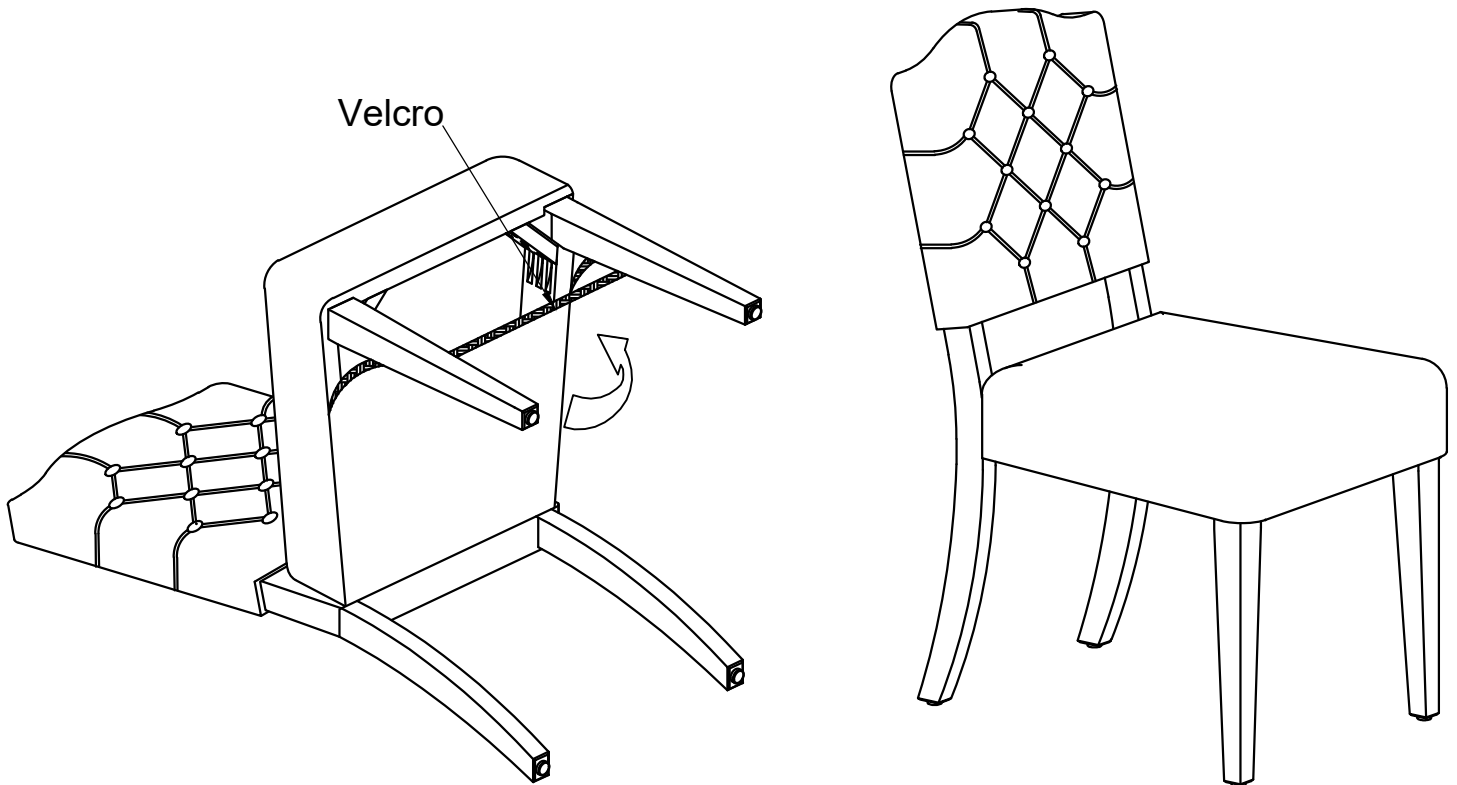

**COMPLETE**